

AMAZE

BUILDING MATERIALS

PRODUCT OVERVIEW

YOUR ONE-STOP
BUILDING MATERIAL
SOLUTION



 016 531 4883



AMAZE BUILDING MATERIALS
A MEMBER OF AMAZE GROUP OF COMPANIES

TIMBER AND WOOD PRODUCTS



Teco Plywood

A Wide Variety of Thickness and Size



Plywood

A Wide Variety of Thickness and Size



Timbers

Ranging from 1" x 2" to Customized Size and Specs

READY MIXED CONCRETE



Ready Mixed Concrete

Ranging from G10 to G40, Normal Mix, Pump Mix and JKR Mix



Crane Service

16 Tons - 25 Tons Crane Service



Concrete Pump Machine

Concrete Pump for Concrete Casting

CEMENTS

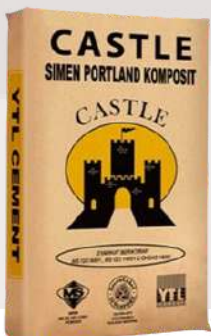

Bag Cements

Portland Composite Cement (PCC)
Ordinary Portland Cement (OPC)



Masonry Cements

Masonry Cement for Brick Laying



Skimcoat & Plastering Products

A Wide Range of Skimcoat and Plastering Products to Suit Your Construction Needs

STEEL PRODUCTS



High Tensile Steel Bars

High Tensile Steel Bars Ranging from Y10 - Y50



Mild Steel Round Bars

Mild steel Rounds Bars Ranging from R6-R50



BRC Wire Meshes

BRC Wire Mesh Ranging from A4- A10



Universal Beams

Universal Beams of Different Size, Spec for Different Construction Needs



Square Hollow Sections

Square Hollow Section of Different Thickness and Size



Rectangular Hollow Sections

Rectangular Hollow Section of Different Thickness and Size



Equal Angle Bars

Equal Angle Bars of Different size, thickness



Unequal Angle Bars

Unequal Angle Bars of Different Size, Thickness



Mild Steel Flat Bars

Mild Steel Flat Bars of Different Dimension, Size and Thickness



Rolled BRC

Rolled BRC of Different Specification



Mild Steel Plates

Mild Steel Plates of Different Thickness
*Customizable Based on Construction Need



Security Fencing

Security Fencing of Different Spec and Dimension for Fencing Purpose

PRECAST CONCRETE PRODUCTS



R.C. Spun Pipe/ Pipe Culvert

Pipe Diameter Ranging from 300mm to 1800mm

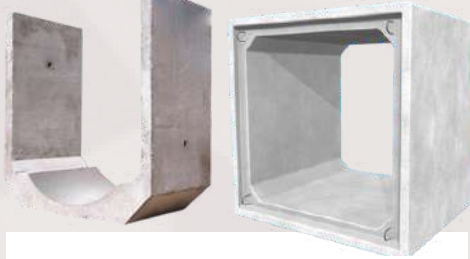

R.C. U Drain/ Box Culvert

Wide Variety of Dimension for Different Construction Needs



R.C. L Shaped Wall

Wide variety of Dimensions for Different Construction Needs



Precast Concrete Piles

Precast PC or RC Piles of Different Dimensions



Concrete Pillar

A Wide Variety of Length and Size for Different Construction Needs



Concrete Manhole Cover

Precast Concrete Manhole Cover



R.C. Half Round Drain

Half Round Drain with Different Dimension for Different Construction Needs

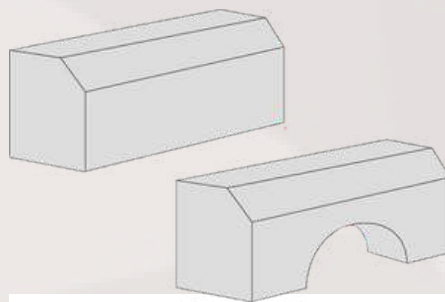

Road Krebs

Concrete Road Krebs with Hole and without Hole, Both Sleeping and Standing Krebs



TNB Sub Station Precast Products

Precast Products for Construction of TNB Sub Station

ROOFING PRODUCTS

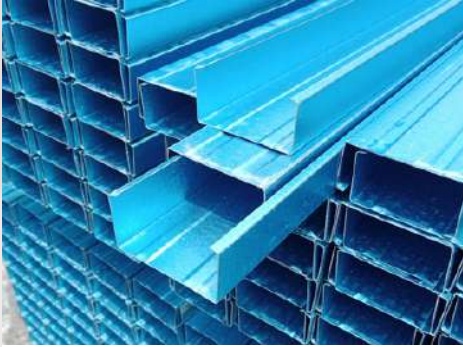

C Channel

C Channel of Different Dimension and Thickness



C Purlin

C Purlin of Different Dimension and Thickness

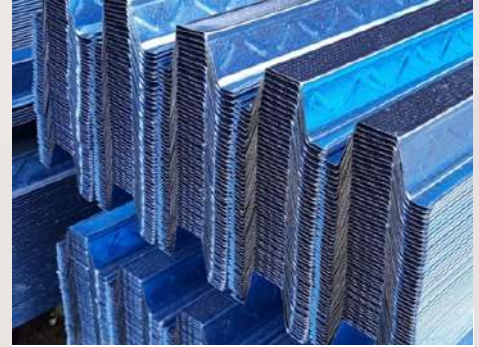

Battens

Battens of Different Dimension and Thickness

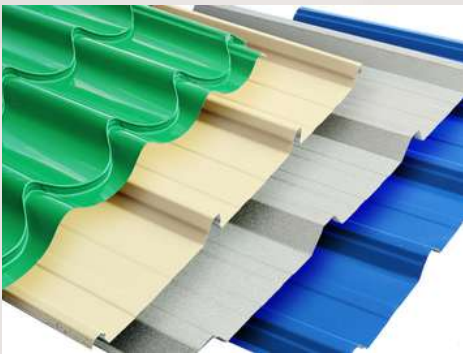

Metal Roofing Sheet

Metal Roofing Sheet of Different Specification, Thickness and Length



Roofing Tiles

Concrete and Clay Roofing Tiles



Insulation Materials

Aluminum Foils, Fiberglass Wool

QUARRY PRODUCTS



Crusher Run

Limestone and Granite Crusher Run



Aggregates

Aggregates



Sand

Pasir Cuci, Pasir Kasar

BRICKS, AAC BLOCKS, PAVERS



Cement Brick

Available in Loose or Pallet Form

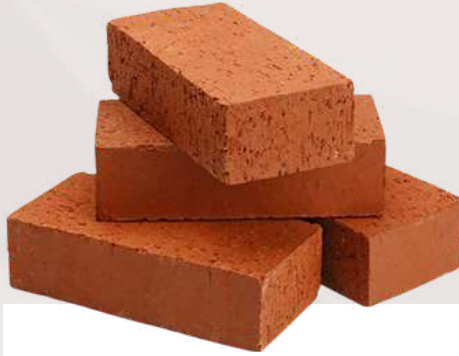

Red Clay Brick

Available in Loose or Pallet Form

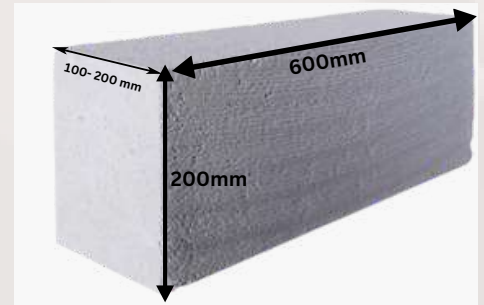

AAC Block / Lightweight Block

Multiple Width Size of 100mm, 125mm, 150mm and 200 Thickness



Clay & Concrete Pavers

A Wide Variety of Size and Shape

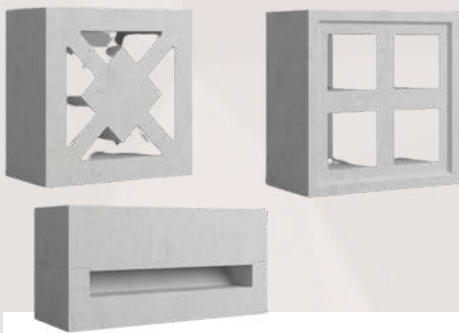

Ventilation Block

A Wide Variety of Size and Shape



Hollow Block

A Wide Variety of Size and Shape

DOOR & WINDOW



Galvanized Door and Window Frame

G.I Door and Window Frame
Naco Louvres Frame



Wood, Fire, PVC Doors

Fire Resistant Doors, Plywood Flush Door,
Solid Door, PVC Toilet Door, Metal Door

PLUMBING PRODUCTS



PVC/ UPVC Pipe & Fittings
A Wide Variety of Specs, Size and Products



Vitrified Clay Pipes & Fittings
A Wide Variety of Specs, Size and Products



POLYPROPYLENE-RANDOM (PP-R) PIPE
Pipes That Transports Cold and Hot Water for Cooling and Heating Purposes



HDPE Pipes & Fittings
A Wide Variety of Specs, Size and Products



Individual Septic Tanks
Individual Septic Tank with Different Capacity from 6PE



Water Tanks
Water Tanks Made Up of Different Materials with Different Capacities

CONSTRUCTION MACHINERIES



Backhoe Service
Backhoe for Construction General Purpose



Crane Service
16 Tons - 25 Tons Crane Service



Skylift Service
Skylift for Working at Height

OTHER PRODUCTS



Scaffolding

Scaffoldings for Construction Purpose with CIBD Certifications



Corner Beams

Corner Beams for Plastering and Skimcoat Purpose



Fibre Mesh

Fibre Mesh for Plastering and Skimcoat Purpose



Gypsum Boards

Gypsum Boards for Ceiling and Partition Usages

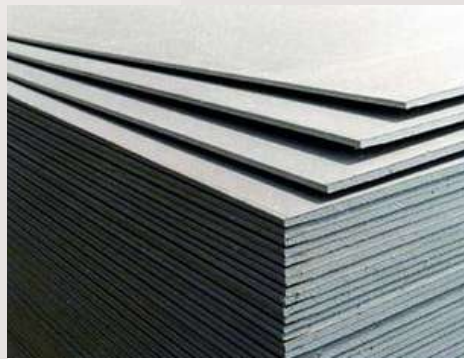

Fibre Cement Boards

Fibre Cement Boards for Construction Purpose



PVC Groove Line

PVC Groove Line for Plastering According to Building Designs



Paint & Chemicals

Paints, Waterproofing and Other Construction Chemicals



Sanitary Products

Sanitary Products Ranging from Toilet Bowl, Basin, Urinator, etc



Floor Tiles

Floor Tiles of Different Design and Dimensions



Fascia Boards

Papan Cantik for Roofing System



Personal Protective Equipment (PPE)

Safety Helmets, Safety Shoes, Safety Harness, Safety Vests. (Logo Printing Available)



Contact Us for Other Product Enquiries

AMAZE

BUILDING MATERIALS

Ipoh Corporate Office (HQ)

Suite D, No.22, Jalan Canning Estate
Canning Garden
31400 Ipoh Perak Malaysia
Tel: +605 541 6622



016 531 4883



bm@amazegroup.com.my



www.amazegroup.com.my



TRADING AS

AMAZE DEVCON SDN. BHD.

202201001618 (1447315-W)

A MEMBER OF AMAZE GROUP OF COMPANIES